













kWh	kvarh	kVAh	Active, Reactive and Apparent Energy
BS	DIN	BS / DIN housing	
			Multiple connection types
CT	Direct or current transformer connection		
IP54	Ingress protection		
	Load profile		
	Optical port		
	Real-time clock		
	Event log		
RS485	RS485 interface		
tariff 4	Multi-rate registration		
MID B	IEC 1	Accuracy class	
	Magnetic field detection		
	Photovoltaic ready		
max	Maximum demand		
	4 Quadrant measurement		

With a future-proof design the Polyphase MT174 is ready to suit many diverse customer requirements. High quality manufacturing process enables the meter to deliver the performance, expected in residential and small commercial environments. It includes a wide variety of functionalities:

- Extensive anti-tampering features
- Import/export energy management
- Photovoltaic friendly design
- RS communication interface
- Up to four tariff models
- Extended load profile
- Time-of-use (TOU) – internal tariffication



Meter dimensions

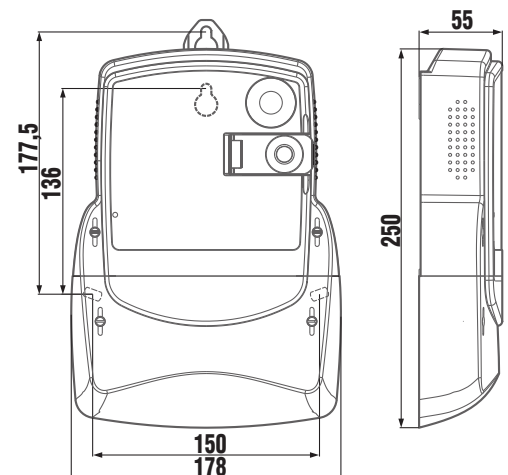

Type overview

		MT174-D1 BS	MT174-D1 DIN	MT174-D2 BS	MT174-D2 DIN	MT174-T1 CT
Network	Low voltage	●	●	●	●	●
Connection type	3P2W	●	●			
	3P4W			●	●	●
Communication	RS485	●	●	●	●	●
	Optical port	●	●	●	●	●
Input – output options	Output S0	●	●	●	●	●
	Output OPTOMOS	●	●	●	●	●
	Tariff input (1 or 2)	●	●	●	●	●

Technical specifications

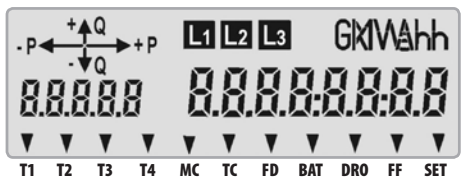
		MT174-D1 BS	MT174-D1 DIN	MT174-D2 BS	MT174-D2 DIN	MT174-T1 CT
Nominal voltage	U_n	3x230/400 V, 3x230 V, 230 V, 3 x 400 V				
Voltage range		0.8 – 1.15 U_n				
Reference frequency		50 Hz or 60 Hz				
Current	Base current I_b	5A or 10A				1 A
	Starting current I_{st}	5A => Class 2: 0.025A, Class 1: 0.02A 10A => Class 2: 0.05A, Class 1: 0.04A				20 mA
	Maximal current I_{max}	85 A, 100 A, 120 A				6 A
Accuracy class	Active energy	Class 2 or Class 1 A or B (EN 50470 - 3, IEC 62053-21 or -23)				
	Reactive energy	Class 3 or Class 2				
	Apparent energy	Class 3 or Class 2				
Real-time clock	Accuracy	Better than ± 3 min/year at 23 °C				
	Back-up power supply	Li battery: 5 years, life time up to 20 years				
Temperature ranges (IEC 62052-11)	Operation	-40 °C ... +60 °C; extended -40 °C ... +70 °C				
	Storage	-40 °C ... +80 °C				
Ingress protection IEC 60529		IP54				
Liquid Crystal Display						

Basic functionality

Measurement features

- Two way ("energy") measurements
- Active, Reactive and Apparent energy and demand in 3-phase 4- and 3-wire networks
- Measurement by phases and polyphase, quantities of measurement: Voltages by phases, Currents by phases, Power factors by phases, Frequency
- Measurement of instantaneous power

Tariff functions

- Time-of-use (TOU) measurement of active energy and maximum demand (up to 4 tariffs, 10 seasons, 10 weekly programs, 10 daily definitions, 10 tariff change over inside individual daily tariff programs, 46 holidays)

Load profiles

- Load profile recorder with up to 8 channels
- Possibility to set the recording period on 5, 10, 15, 30, 45 or 60 minutes

Communication

- IEC 1107 compliance
- Two communication interfaces:
 - Optical port
 - RS485

Real-time clock (RTC)

- Compliant with IEC 62054-21 standard
- RTC with calendar, based on 32 kHz quartz crystal
- RTC accuracy: better than ± 3 min/year, operation reserve: 5 years, expected Li battery life time: 20 years
- Counter of elapsed time of RTC operation
- Li battery enables data display on LCD when meter is in no-power state

Specifics

- Backlit LCD display
- Detection of opening main and terminal cover
- External magnetic field detector
- Detection of meter wiring
- Photovoltaic ready
- Secured communication channels
- Load profile on LCD
- Change of set parameters protected with a sealed pushbutton
- Indication of low Li battery

Iskraemeco (UK) Ltd.

Building 1010 Cambourne Business Park
Cambourne Cambridge CB23 6DP
Telephone: +44 (0) 1223 597912, Telefax: +44 (0) 1223 598001
Direct: +44 (0) 131 718 6050, e-mail: sales@iskraemeco.co.uk



Iskraemeco, Energy Measurement and Management
4000 Kranj, Savska loka 4, Slovenia
Telephone: +386 4 206 40 00
http://www.iskraemeco.si, e-mail: info@iskraemeco.si